



Calhoun: The NPS Institutional Archive
DSpace Repository

Theses and Dissertations

1. Thesis and Dissertation Collection, all items

2006-12

**Object Orientated Programmable Integrated
Circuit (OOPIC) upgrade and evaluation for
Autonomous Ground Vehicle (AGV)**

Hoffman, Andrew J.

Monterey California. Naval Postgraduate School

<http://hdl.handle.net/10945/2434>

Downloaded from NPS Archive: Calhoun



Calhoun is the Naval Postgraduate School's public access digital repository for research materials and institutional publications created by the NPS community. Calhoun is named for Professor of Mathematics Guy K. Calhoun, NPS's first appointed -- and published -- scholarly author.

Dudley Knox Library / Naval Postgraduate School
411 Dyer Road / 1 University Circle
Monterey, California USA 93943

<http://www.nps.edu/library>



**NAVAL
POSTGRADUATE
SCHOOL**

MONTEREY, CALIFORNIA

THESIS

**OBJECT ORIENTED PROGRAMMABLE INTEGRATED
CIRCUIT (OOPIC) UPGRADE AND EVALUATION FOR
AUTONOMOUS GROUND VEHICLE (AGV)**

by

Andrew J. Hoffman

December 2006

Thesis Advisor:
Co-Advisor:

Richard Harkins
Nancy Haegel

Approved for public release: distribution is unlimited

THIS PAGE INTENTIONALLY LEFT BLANK

REPORT DOCUMENTATION PAGE			Form Approved OMB No. 0704-0188
Public reporting burden for this collection of information is estimated to average 1 hour per response, including the time for reviewing instruction, searching existing data sources, gathering and maintaining the data needed, and completing and reviewing the collection of information. Send comments regarding this burden estimate or any other aspect of this collection of information, including suggestions for reducing this burden, to Washington headquarters Services, Directorate for Information Operations and Reports, 1215 Jefferson Davis Highway, Suite 1204, Arlington, VA 22202-4302, and to the Office of Management and Budget, Paperwork Reduction Project (0704-0188) Washington DC 20503.			
1. AGENCY USE ONLY (Leave blank)	2. REPORT DATE December 2006	3. REPORT TYPE AND DATES COVERED Master's Thesis	
4. TITLE AND SUBTITLE Object Oriented Programmable Integrated Circuit (OOPic) Upgrade and Evaluation for Autonomous Ground Vehicle (AGV)		5. FUNDING NUMBERS	
6. AUTHOR(S) Andrew J Hoffman		8. PERFORMING ORGANIZATION REPORT NUMBER	
7. PERFORMING ORGANIZATION NAME(S) AND ADDRESS(ES) Naval Postgraduate School Monterey, CA 93943-5000		10. SPONSORING/MONITORING AGENCY REPORT NUMBER	
9. SPONSORING /MONITORING AGENCY NAME(S) AND ADDRESS(ES) N/A		11. SUPPLEMENTARY NOTES The views expressed in this thesis are those of the author and do not reflect the official policy or position of the Department of Defense or the U.S. Government.	
12a. DISTRIBUTION / AVAILABILITY STATEMENT Approved for public release: distribution is unlimited		12b. DISTRIBUTION CODE	
13. ABSTRACT (maximum 200 words) A small, low-power Object-Oriented Programmable integrated circuit (OOPic) micro-controller, was integrated and tested with the architecture for an autonomous ground vehicle (AGV). Sensors with the OOPic, and the XBee Wireless Suite were included in the integration. Tests were conducted, including range and time operation analysis for wireless communications for comparison with the legacy BL2000 microcontroller. Results demonstrated long battery life for the electronics of the robot, as well as communication ranges exceeding high power modems. The OOPic was limited by processing power and an ability to interpret some incoming form data. Consequently its use as a one for one replacement for the BL2000 is limited. However combined use with the BL2000 shows promise as a replacement for sensor monitoring and a hardware substitute for the legacy Pulse Width Modulator.			
14. SUBJECT TERMS Robotics, OOPic, Microprocessor		15. NUMBER OF PAGES 61	16. PRICE CODE
17. SECURITY CLASSIFICATION OF REPORT Unclassified	18. SECURITY CLASSIFICATION OF THIS PAGE Unclassified	19. SECURITY CLASSIFICATION OF ABSTRACT Unclassified	20. LIMITATION OF ABSTRACT UL

NSN 7540-01-280-5500

Standard Form 298 (Rev. 2-89)
Prescribed by ANSI Std. Z39-18

THIS PAGE INTENTIONALLY LEFT BLANK

Approved for public release: distribution is unlimited

OBJECT ORIENTED PROGRAMMABLE INTEGRATED CIRCUIT (OOPIC)
UPGRADE AND EVALUATION FOR AUTONOMOUS GROUND VEHICLE (AGV)

Andrew J. Hoffman
Lieutenant, United States Navy
B.A., The University of North Carolina, 1999

Submitted in partial fulfillment of the
requirements for the degree of

MASTER OF SCIENCE IN APPLIED PHYSICS

from the

NAVAL POSTGRADUATE SCHOOL
December 2006

Author: Andrew J. Hoffman

Approved by: Richard Harkins
Thesis Advisor

Nancy Haegel
Thesis Co-Advisor

James Luscombe
Chairman, Department of Physics

THIS PAGE INTENTIONALLY LEFT BLANK

ABSTRACT

A small, low-power Object-Oriented Programmable integrated circuit (OOPic) micro-controller was integrated and tested with the architecture for an autonomous ground vehicle (AGV). Sensors with the OOPic, and the XBee Wireless Suite were included in the integration. Tests were conducted, including range and time operation analysis for wireless communications for comparison with the legacy BL2000 microcontroller. Results demonstrated long battery life for the electronics of the robot, as well as communication ranges exceeding high power modems. The OOPic was limited by processing power and an ability to interpret some incoming form data. Consequently its use as a one for one replacement for the BL2000 is limited. However combined use with the BL2000 shows promise as a replacement for sensor monitoring and a hardware substitute for the legacy Pulse Width Modulator.

THIS PAGE INTENTIONALLY LEFT BLANK

TABLE OF CONTENTS

I.	INTRODUCTION	1
A.	NPS SMART DEVELOPMENT	1
B.	MOTIVATION	3
II.	ROBOT COMPONENTS AND CONTROL	5
A.	DESIGN OVERVIEW	5
B.	OVERVIEW OF HARDWARE	6
1.	OOPIC II+ Microcontroller	6
2.	XBEE Pro Wireless Module	9
a.	<i>Idle Mode</i>	11
b.	<i>Transmit/Receive Modes</i>	12
c.	<i>Sleep Mode</i>	12
d.	<i>Command Mode</i>	12
3.	SRF08 Ultra Sonic Range Finder	12
4.	Sharp GP2D12 Infrared Range Finder	16
5.	Compass Module	19
6.	I2C Bus	20
III.	TESTING AND RESULTS	23
A.	BL2000 VERSUS OOPIC	23
B.	802.11G WIRELESS ROUTER VERSUS XBEE WIRELESS MODULE	26
C.	PULSE WIDTH MODULATION (PWM)	28
D.	INFRARED RANGE FINDER	31
E.	SRF08 ULTRASONIC RANGE FINDER	34
IV.	CONCLUSIONS AND FUTURE WORK	37
A.	CONCLUSIONS	37
B.	FUTURE WORK	37
	LIST OF REFERENCES	41
	INITIAL DISTRIBUTION LIST	43

THIS PAGE INTENTIONALLY LEFT BLANK

LIST OF FIGURES

Figure 1.	Bender Prototype Robot.....	2
Figure 2.	Agbot Prototype Robot.....	2
Figure 3.	Autonomous Ground Vehicle (AGV) Prototype.....	3
Figure 4.	Netgear Wireless router vs. XBee wireless module.....	4
Figure 5.	BL200 wildcat vs. OOPic II+.....	4
Figure 6.	Functional diagram of OOPic and sensor integration.....	5
Figure 7.	Component layout on AGV base.....	6
Figure 8.	OOPic Board Layout [From: Ref. 9].....	7
Figure 9.	XBee Pro Wireless Module.....	9
Figure 10.	XBee Pro USB Module.....	9
Figure 11.	XBee-OOPic Serial Connection.....	10
Figure 12.	XBee Modes of Operation [From: Ref. 5].....	11
Figure 13.	SRF08 Front View [From: Ref. 10].....	13
Figure 14.	SRF08 Beam Pattern [From: Ref. 10].....	13
Figure 15.	A generic ultrasonic detection sensor [From: Ref. 10].....	15
Figure 16.	IR Ranger Front View.....	16
Figure 17.	GP2D12 Triangulation Diagram [From: Ref. 11]....	17
Figure 18.	GP2D12 Voltage Lookup Table [After: Ref. 11]....	18
Figure 19.	I2C Connection Schematic [From: Ref. 3].....	20
Figure 20.	I2C Communication Scheme [From: Ref. 8].....	21
Figure 21.	Average file download times for OOPic and BL2000.....	25
Figure 22.	(A) The actual PWM circuit on AGV. (B) The PWM circuit diagram. [From: Ref. 6].....	28
Figure 23.	OOPic program listing for 50% duty cycle.....	29
Figure 24.	PWM waveform output for 50% duty cycle. (A) OOPic. (B) AGV circuit [From: Ref. 6].....	30
Figure 25.	PWM waveform output for 75% duty cycle. (A) OOPic. (B) AGV circuit [From: Ref. 6].....	30
Figure 26.	Output voltage versus distance to objects for the IR ranger [After: Refs. 6 and 11].....	31
Figure 27.	OOPic Digital Conversion versus Output Voltage..	33
Figure 28.	OOPic Digital Conversion versus Distance to Object for IR Ranger.....	34
Figure 29.	SRF08 distance to object for BL2000 and OOPic for various materials.....	35
Figure 30.	DS-GPM Global Positioning System Module [From: Ref. 13].....	38
Figure 31.	CMUCAM, low power alternative to web cam [From: Ref. 14].....	39

THIS PAGE INTENTIONALLY LEFT BLANK

LIST OF TABLES

Table 1.	Specifications of OOPic versus BL2000 microprocessor [After: Refs. 1, 9 and 13].....	24
Table 2.	Specification of Netgear Wireless Router versus XBee Wireless Module [After: Ref. 5].....	26

THIS PAGE INTENTIONALLY LEFT BLANK

LIST OF EQUATIONS

Equation 1.	Distance to an object from the ultrasonic rangefinder [From: Ref. 4].....	14
Equation 2.	(A) Range equation in inches. (B) Range Equation in centimeters. [After: Ref. 2].....	18
Equation 3.	Updated Range equation for the IR Ranger.....	34

THIS PAGE INTENTIONALLY LEFT BLANK

ACKNOWLEDGMENTS

Thanks to Major Ben Miller for all of his previous work with AGV and his guidance throughout this project. Thanks to the lab group: LT John Herkamp, ENS Tom Dunbar and ENS Todd Williamson for all their advice, levity and support. Thanks to the Spring 2006 SE4015 class for all of their work on the base of the robot. Finally, special thanks to my thesis advisor Professor Richard Harkins for allowing me to see this project through its many false starts.

THIS PAGE INTENTIONALLY LEFT BLANK

I. INTRODUCTION

A. NPS SMART DEVELOPMENT

The objective of the Small Robot Technology (SMART) initiative at the Naval Postgraduate School (NPS) is to develop robots for military use. Robots have many advantages in military functions. They can be small, covert, low-cost, and do not put lives at risk.

One of the current research programs within SMART is to develop an autonomous robot platform for covert reconnaissance and mine/Improvised Explosive Device (IED) detection and identification. To accomplish this, the robot will need to be small enough to be man deployable, able to operate in various harsh environments, extend time on station, and have reliable communication with other operational assets.

The first autonomous robot developed in the SMART program was known as Bender (see Figure 1). Bender was constructed entirely from commercial off the shelf hardware and was intended to develop and test sensor and control systems, computer programs and the JAVA based graphical user interface (GUI). The second-generation robot named Lopez was developed by LT Jason Ward and provided the foundation for the third prototype, Agbot (see Figure 2). Agbot was a combined effort between Case Western University and NPS [Ref. 2]. The robot was designed with surf zone operations as its primary mission and was engineered with a biologically based gate, designed to overcome obstacles found in a surf-zone environment that a small, wheeled

vehicle may not be able to navigate. More information on Agbot and biological gait can be found in the thesis of ENS Thomas Dunbar [Ref. 2].

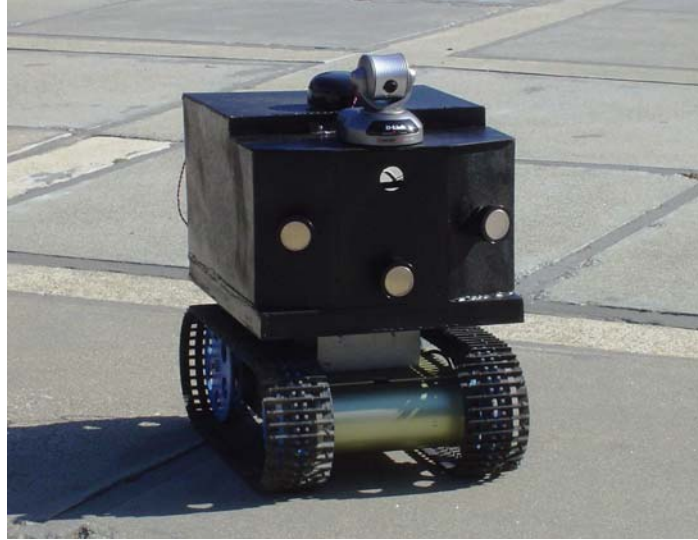

Figure 1. Bender Prototype Robot.

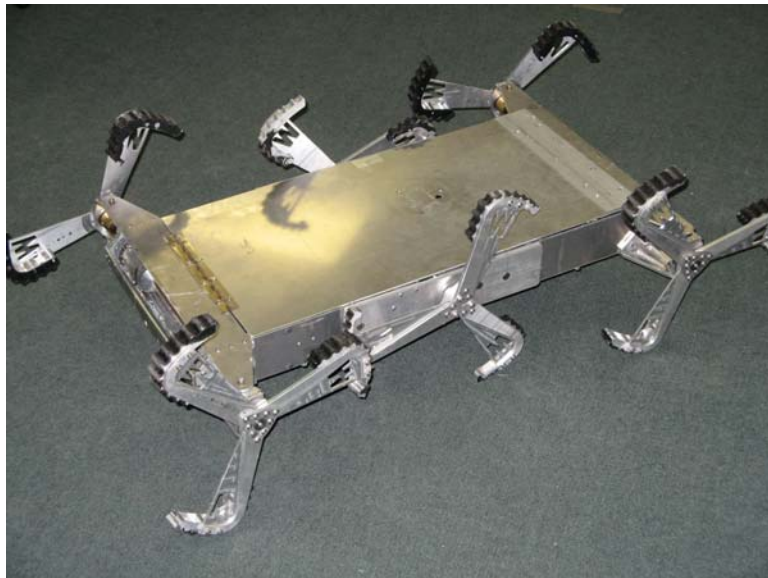

Figure 2. Agbot Prototype Robot.

The most recent SMART project was designed as an autonomous vehicle intended as a method of locating and

identifying IED emplacements. MAJ Benjamin Miller designed and constructed the latest prototype, called Autonomous Ground Vehicle (AGV) (see Figure 3). AGV was equipped with extensive navigation sensors and motion detectors to aid in its missions. All of the sensors and detectors were controlled by a BL2000 Wildcat microprocessor and a Netgear wireless router with 802.11 wireless protocol communications. The combination provided quick, reliable communication between AVG and the base computer, however there were limitations to the BL2000 and wireless router. The wireless router drained the AGVs battery life very quickly and had range and security limitations. The BL2000 microprocessor had limited analog outputs, cumbersome programming, and limited I2C compatibility [Ref. 6].

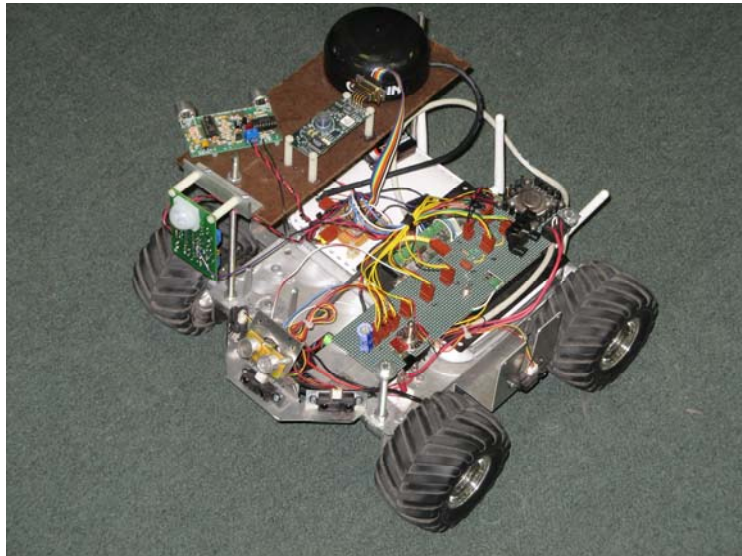

Figure 3. Autonomous Ground Vehicle (AGV) Prototype.

B. MOTIVATION

The newest generation prototype was designed to take the sensors from AGV and integrate them onto a low power, low cost microprocessor and small form factor communication

suite designed for small robot control. The OOPic II+ microprocessor and XBee wireless systems were utilized to control and process the sensors. The size difference of the hardware installed on AGV and the new items being tested is illustrated below (see Figures 4 and 5).



Figure 4. Netgear Wireless router vs. XBee wireless module.



Figure 5. BL200 wildcat vs. OOPic II+.

II. ROBOT COMPONENTS AND CONTROL

A. DESIGN OVERVIEW

The functional design around the OOPic is part of what makes this microcontroller unique. It was designed to be compatible with many common sensors, making integration of hardware and coding seamless. Figure 6 shows the functional diagram of the OOPic and the integration of its sensors.

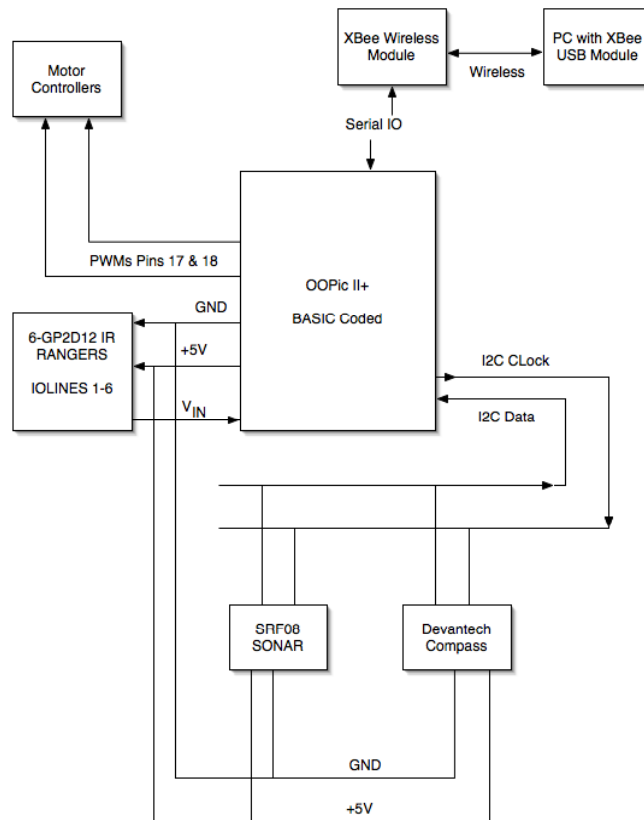

Figure 6. Functional diagram of OOPic and sensor integration.

Figure 7 shows a photo layout of AGV's base with nominal placement of the OOPic and its integrated sensors. The integration and testing of each sensor will be discussed.

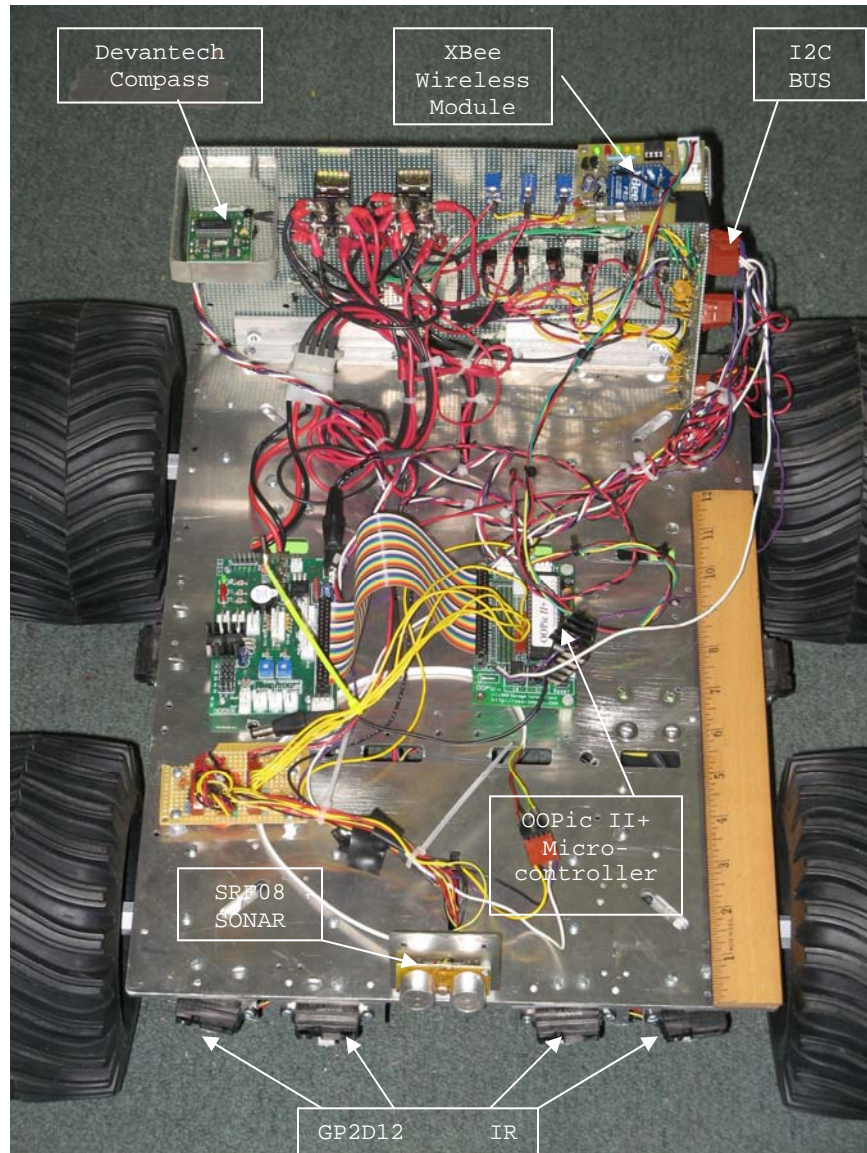

Figure 7. Component layout on AGV base.

B. OVERVIEW OF HARDWARE

1. OOPIC II+ Microcontroller

The Object-Orientated Programmable integrated circuit (OOPic) (see Figure 8) is the first PICmicro to use an

Object-Oriented approach to hardware control. The OOPic was pre-programmed with Objects designed to provide optimized interface with hardware. The OOPic has multi-language capability and can be programmed in Basic, C, or JAVA. The Integrated Multi-Language Development Environment (IDE) is based on Visual Basic and was provided by the OOPic manufacturer, Savage Industries, Inc. The IDE included a text editor, debugger, and allowed selection of the OOPic Firmware Version.

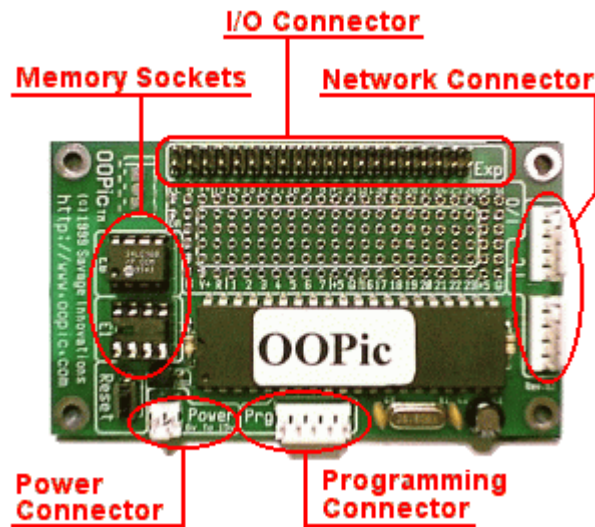

Figure 8. OOPic Board Layout [From: Ref. 9].

The initial PC to OOPic connection consists of a parallel port cable out of the PC, down to a 5-pin connector on the OOPic. The parallel connector allows for only one-way communication from the PC to the OOPic [Ref. 1]. The original wired connection was later replaced with a wireless connection that provided two-way serial communication between the OOPic and PC.

A PIC16F877 Microchip is the core of the OOPic and has an extensive library of hardware controls preprogrammed.

The PIC16F877 is clocked at 20MHz; it includes seven 10-bit analog to digital channels, 31 input/output ports, 86 bytes of object memory, and 72 bytes of variable memory space [Ref 1]. The OOPic also includes two lines dedicated as Pulse Width Modulators (PWM), a serial in and serial out, as well as dedicated I2C clock and data lines.

The OOPic has two upgradeable memory modules, which allows for great flexibility. The program code is stored in the removable electronically erasable programmable read-only memory (EEPROM) while all of the data from objects are stored within the internal memory of the PICmicro. The EEPROM can be easily upgraded to support more robust programs or larger amounts of data. The original OOPic comes installed with a single 8KB EEPROM.

What sets the OOPic apart from other microcontrollers is the extensive library of embedded objects that can be used for data processing as well as hardware control and communication [Ref. 7]. They fall into the following areas:

- Hardware Objects control the functionality of the OOPic hardware circuitry, including analog-to-digital conversion (A2D), 1,4,8, and 16 bit input/output (I/O), servo control, and timers [Ref. 7]
- Processing Objects aid in mathematical, logical and data tasks. They include the use of virtual circuits, data conversion, real-time clock, and integer math functions [Ref. 7].
- Variable Objects are the means to store data. It allows access to RAM and EEPROM as well as storage for bits, nibbles, bytes, and words [Ref. 7].

- System Objects allow access to the system parameters, including reset, pause, timers and voltage sources [Ref. 7].

2. XBEE Pro Wireless Module

The XBEE Pro wireless module (Zigbee) is a low power wireless transceiver that operates on an 802.15.4 protocol. It consists of two XBEE Pro RF modules, one of which is connected to the OOPic via four pin serial connection (see Figure 9). The second module is encased in a base station and is connected to the PC via USB port (see Figure 10). The modules operate within the Industrial, Scientific, and Mechanical (ISM) 2.4 GHz frequency band.



Figure 9. XBee Pro Wireless Module.



Figure 10. XBee Pro USB Module.

The XBee serial module is connected to the OOPic via a four-pin header, with +5v, Ground, and Pin 22 and 23, which are serial in and out, respectively (see Figure 11).

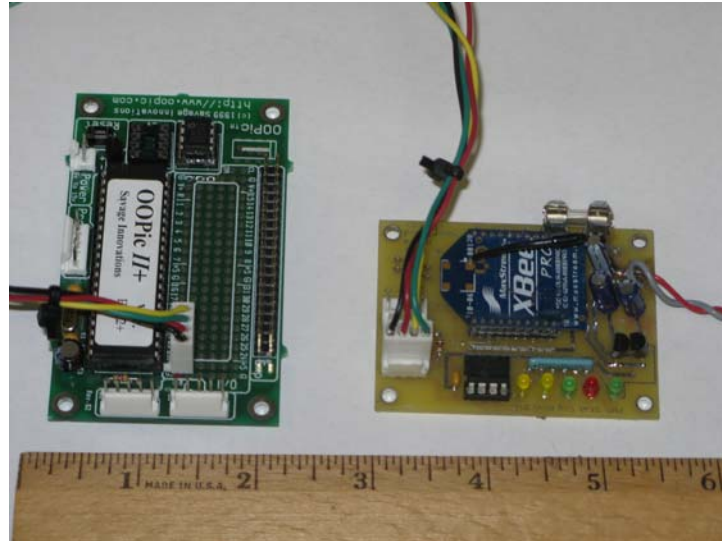

Figure 11. XBee-OOPic Serial Connection.

The XBee system transfers a standard asynchronous serial data stream and is capable of transfer with multiple units. The USB base station allows for rapid integration into legacy systems. The system operates at ranges up to 300 ft indoors and up to 1-mile outdoors line of sight. The data are transmitted at a power of 100mW with a data rate of 250,000 bps, with an interface data rate of 1200-115200 bps [Ref. 5].

The Xbee serial module is small form factor, with dimensions of 2" by 2.5", and low power consumption with receive currents of 55mA and transmit currents of 214mA at 3.3V.

The XBee system operates on a 802.15.4 protocol, which is task group 4 of the 15th working group of the IEEE 802.

Task group 4 was formed to design a Low Power Wireless Personal Area Network (WPAN). It sacrificed data rate for battery longevity [Ref. 5].

There are five basic modes of operation to the XBee system as shown in Figure 12.

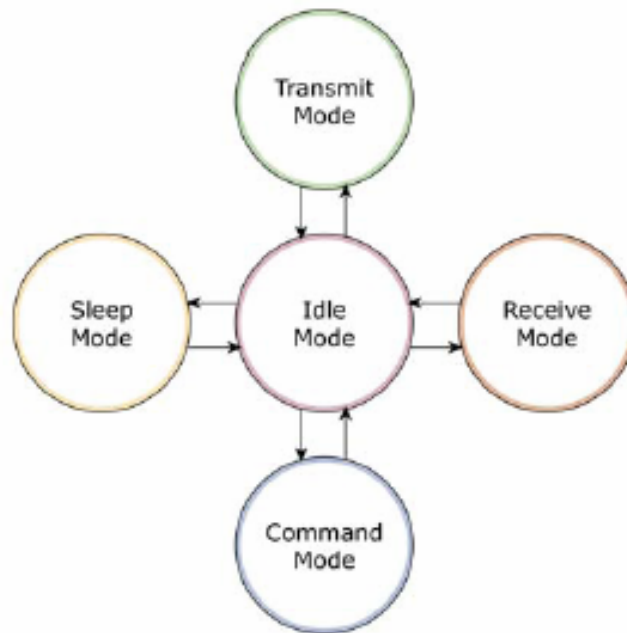

Figure 12. XBee Modes of Operation [From: Ref. 5].

a. Idle Mode

When the modem is not transmitting or receiving data, the module is in Idle Mode. The module changes to other modes of operation under the following conditions:

- Transmit mode when serial data are received in the DI Buffer
- Receive mode when RF data are received through the antenna
- Sleep mode when conditions are met
- Command mode when the proper sequence is issued.

b. Transmit/Receive Modes

There are two ways to transmit data; the first is Direct Transmission, which sends the data immediately to the destination address. The second is Indirect Transmission, which holds the data until the destination module requests the data. This type of transmission can only occur in a Coordinator Mode. The Direct Transmission will occur by default if all of the network devices are End Devices. For current use, Direct Transmissions is utilized, as there are only two modules. However, for future expansion Indirect Transmission will be the optimal method [Ref. 5].

c. Sleep Mode

The RF module enters a state of low-power consumption when in Sleep Mode. To enter sleep mode one of the following condition must be met:

- Pin 9 is asserted high
- The module is idle for a certain amount of time as defined by the Time before Sleep (ST) parameter [Ref. 5].

d. Command Mode

The Command Mode is used to read or modify RF Module parameters. In Command mode incoming characters are interpreted as commands. There are two command mode options, AT Command Mode and API Command Mode. The command modes are not currently utilized for communications.

3. SRF08 Ultra Sonic Range Finder

The SRF08 Ultra Sonic Range Finder is used for object detection and feeds into the collision avoidance systems. The SRF08 communicates with the OOPic via the I2C bus. The SRF08 main sensor is composed of two 400 series transducers, one of which is intended to send the signal,

while the other receives. The two transducers and the front of the SRF08 are seen in Figure 13. The SRF08 is a forward looking sensor, and its beam pattern is shown in Figure 14.



Figure 13. SRF08 Front View [From: Ref. 10].

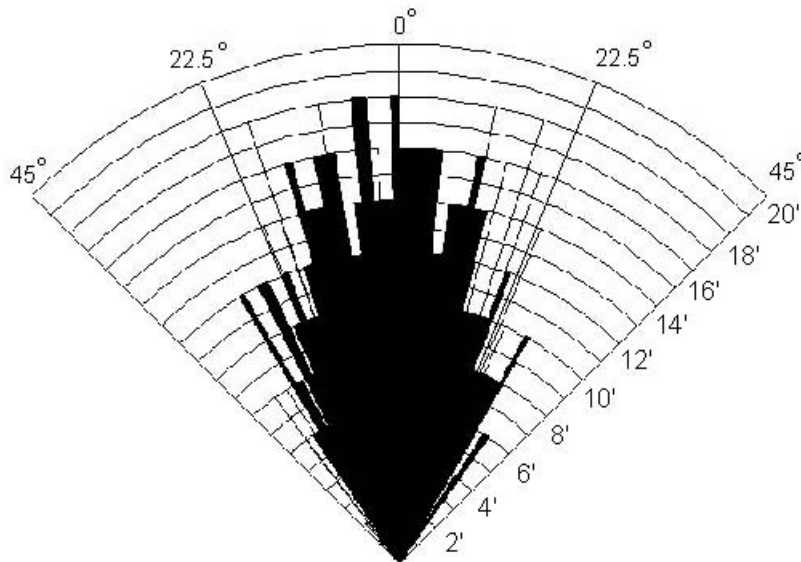

Figure 14. SRF08 Beam Pattern [From: Ref. 10].

The sonar operates to a maximum effective range of six meters. The SRF08's internal registry allows the OOPic via coding and I2c protocol to identify the specific unit and which object distance is read. The two defaults are

centimeters and inches. The physical operation of the SRF08 is based on an ultrasonic pulse with a frequency of 40 kHz emitted from the transmitter. If an object is within the beam pattern, the energy is reflected uniformly within a solid angle, and then received by the second transducer as shown in Figure 15 [Ref. 10]. There is a phase shift in the frequency between the transmitted and reflected waves [Ref. 4]. This the time it takes for the transmitted wave to return is then converted into a distance using the formula shown in Equation 1:

$$L_o = \frac{vt \cos \Theta}{2}$$

Equation 1. Distance to an object from the ultrasonic rangefinder [From: Ref. 4].

In Equation 1, t is the time the ultrasonic wave takes to be sent, hit the object and return. v is the speed of the wave. The angle Θ is solid angle, normal to the receiver and the object. The basic operation of an ultrasonic sensor is shown in Figure 15.

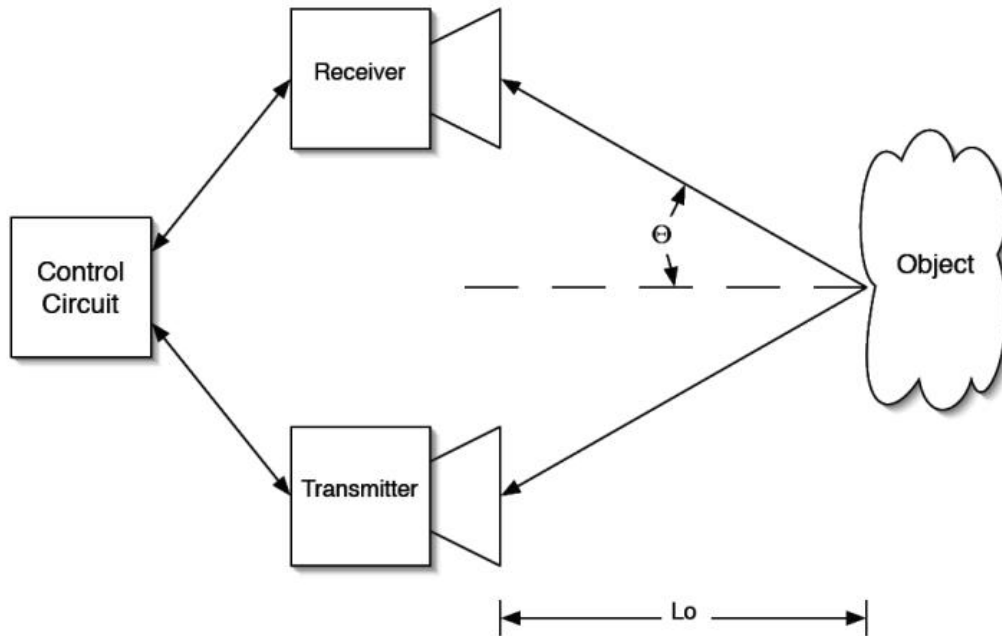

Figure 15. A generic ultrasonic detection sensor [From: Ref. 10].

A piezoelectric transducer is used to generate the ultrasonic wave. A voltage is applied to the piezo-ceramic element, causing the element to flex, resulting in an emitted wave. The return wave elicits a reverse response, hitting the receiver element, causing a flex, thereby generating a voltage into the control circuit [Ref. 4].

There are several factors that can affect the accuracy of the SRF08. The main problem comes from the assumption that the return is coming from a point source and creates a phasing effect. For instance, if the wave is reflected off of a large wall the return read by the receiver is the sum of all of the reflections, thus it can either strengthen or weaken the signal due to interference effects. Additionally, ambient noise that falls around the transmitted frequency can affect the results of the SRF08.

The SRF08 sensor is controlled through the I2C protocol. Multiple SRF08 sensors operating at the same time can result in interference, however by utilizing I2C and individually addressing each SRF08 via the OOPic can eliminate the interference. The SRF08 is also equipped with a front facing light sensor, which is not yet utilized.

4. Sharp GP2D12 Infrared Range Finder

The Sharp GP2D12 Infrared Range Finder shown in Figure 16 is used as a close-in avoidance system, providing constantly updating ranges from 5 to 24 inches. The operation of the GD2D12 is based on triangulation, with a small IR light pulse of about 850 nanometers from the emitter [Ref 11]. The light from the emitter either hits an object and provides a return or does not hit an object. In the case there is no signal return, the detector reading shows no object. In the case the light hits an object and provides a return, it hits the detector and creates a triangle between the 3 points (Figure 17).



Figure 16. IR Ranger Front View.

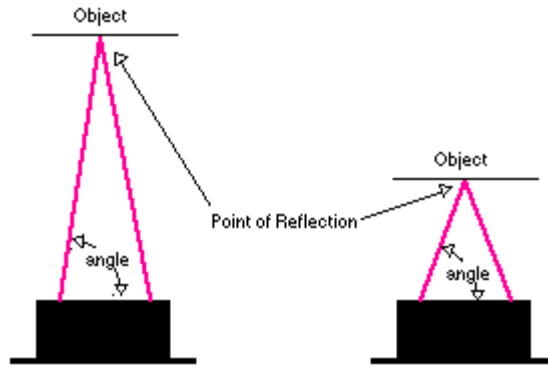

Figure 17. GP2D12 Triangulation Diagram [From: Ref. 11].

The angle varies and is determined by the distance to the object. The receiver in the detector consists of a precision lens that sends the reflected light onto various portions of the enclosed linear CCD array. The CCD array then resolves which angle the reflected light returned at, thereby calculating the distance to the object. This GP2D12 ranger provided great protection from outside interference from ambient light and shows very little dependence on the color of the object [Ref. 11].

The output from the detector is non-linear, and similar voltages must be resolved by the microprocessor to determine the actual range (see Figure 18). The OOPic has an object designed to handle the GP2D12 IR Ranger, called oIRRange. OOPic provided a ground and +5V to the unit and received an analog voltage from the unit into one of the analog to digital ports. The OOPic processed the analog voltage it received and converted it to a digital reading between 0 and 127 based on an internal look up table. The OOPic was then programmed to calculate the range based on the digital byte linearly as shown in Equation 2 [Ref. 1].

$$(A). \text{Range}(in) = \text{digital reading} * 24/128$$

$$(B). \text{Range}(cm) = \text{digital reading} * 61/128$$

Equation 2. (A) Range equation in inches. (B) Range Equation in centimeters. [After: Ref. 2].

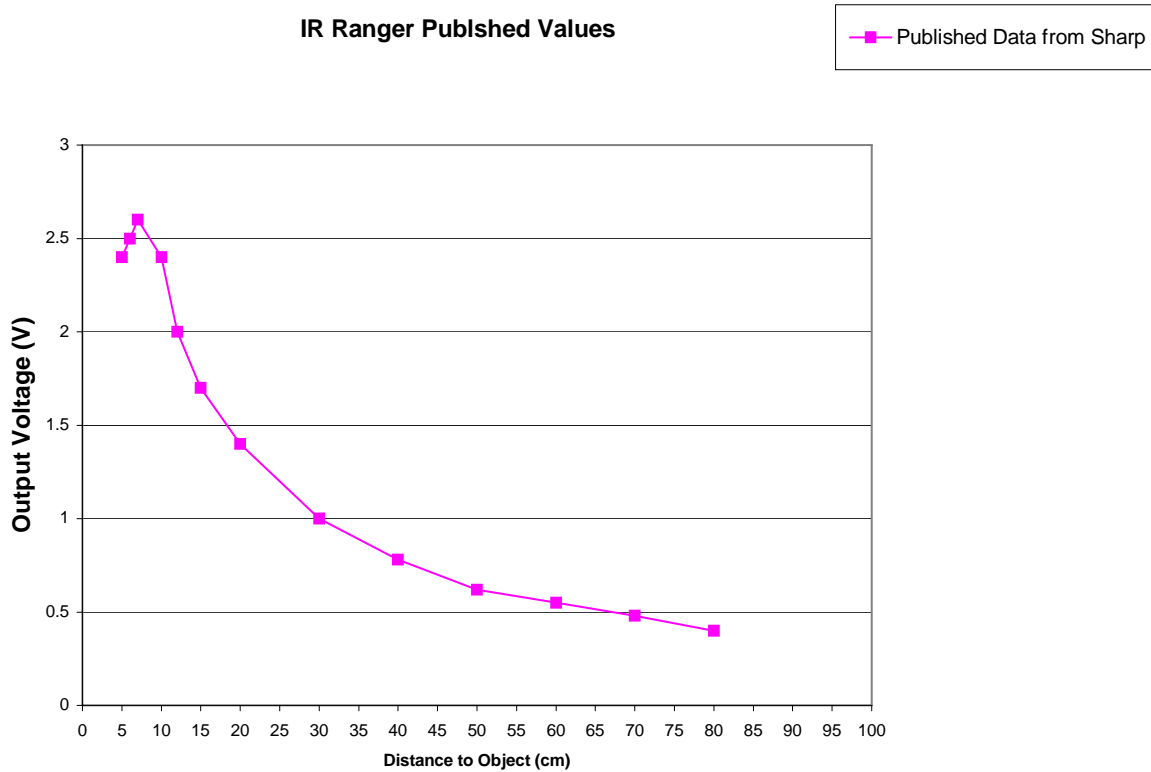

Figure 18. GP2D12 Voltage Lookup Table [After: Ref. 11].

An issue with the ranger was noted. From Figure 18 it was clear that some of the voltages were not singular, and created range ambiguity, and when the object was less than 5 inches from the OOPic tended to default to a maximum reading. Additionally, when the ranger did not detect an object the OOPic regularly returned a distance value of 3 to 4 inches. Clearly these returns would confuse the navigation/collision avoidance program. To address the

issue, any digital reading under 22 (4 inches) defaulted to a full range reading. This solution addressed the issue of no object being detected, preventing the robot from jumping into collision avoidance with no object present. However, it left a problem for range detection under 5 inches, which will be addressed in the future programming by including the SRF08 into the collision avoidance program.

5. Compass Module

The CMPS03 Compass Module is an I2C based component made by Devantech and is designed as a navigation aid for robots. The module provides the direction of the horizontal component of the magnetic flux using the Philips KMZ51 magnetic field sensor. However, this compass module is very susceptible to outside interference from the robotic components or even the surrounding environs. To account for the sensitivity of the magnetic flux sensor the module must be mounted in a location that is away from the most prevalent magnetic interference such as motors. Upon mounting the module on the robotic platform, it can be calibrated to account for the equipment installed on the robot.

The compass module is connected to the OOPic via the I2C bus. The compass module in conjunction with the OOPic has several reading registers that determine the resolution of the compass. Register 1 converts the bearing to a 0-255 value and only consumes a single byte. Register 2 adds significant resolution, reading the compass bearing as a word or a 16 bit unsigned integer in the range 0-3599, representing 0-359.9 degrees [Ref. 1].

6. I2C Bus

The Inter-Integrated Circuit or Inter-IC (I2C) bus provides a communication option for on-board peripheral devices that is not overly taxing on hardware resource needs. It is a simple, low-bandwidth, short-distance protocol that can easily link multiple peripheral devices with its built-in addressing scheme [Refs. 3 and 8].

I2C is a two-wire serial bus (see Figure 19) The I2C wires are serial data (SDA) and serial clock (SCL). Used in conjunction the two-wire system supports serial transmission of 8-bit packets of data, 7-bit addresses as well as control bits. The OOPic is considered to be the master because it initiates the transaction and controls the clock signal. The peripheral device being controlled by the master is considered to be the slave. The OOPic can control up to 127 devices, including additional OOPics as slaves [Ref. 1].

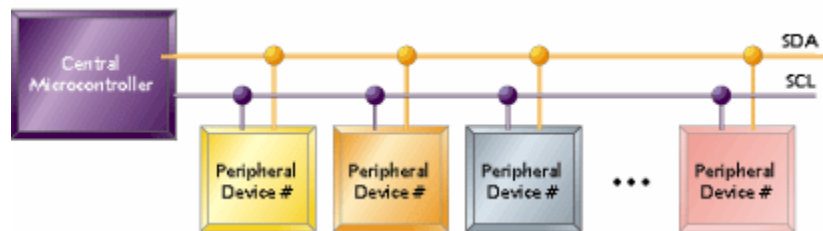

Figure 19. I2C Connection Schematic [From: Ref. 3].

Each slave device comes with a preset address, but the address lower bits are configurable at the board, to avoid ambiguity. The master sends the address of a slave, initiating the transaction. Each slave monitors the bus and responds to its address with the 8-bit data packet (see Figure 20).

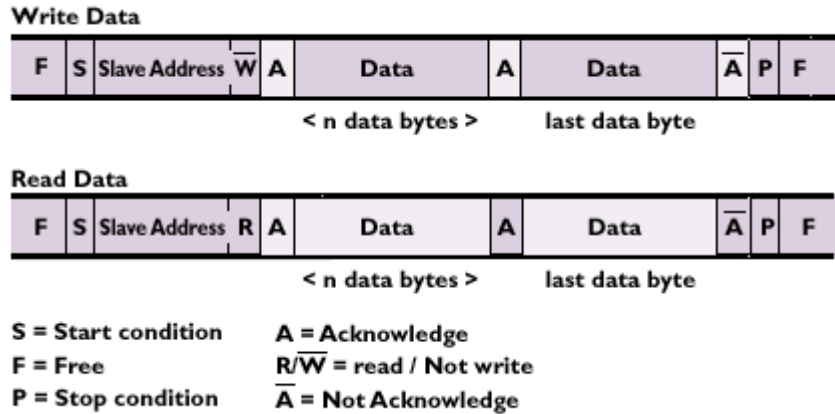

Figure 20. I2C Communication Scheme [From: Ref. 8].

The master starts the communication with the start condition, then sends a 7-bit slave device address, with the most significant bit (MSB) first. The eighth bit after start specifies whether the slave is to transmit or receive. The transmitter begins to send the data string. The slave or the master can be the transmitter, as indicated by the eighth bit. The receiver then issues the ACK bit. The procedure is repeated if additional data need to be transferred [Ref. 3].

THIS PAGE INTENTIONALLY LEFT BLANK

III. TESTING AND RESULTS

Numerous tests were conducted to assess the viability of the OOPic microprocessor versus the BL2000 for use as an onboard computer to control AGV. As the research process progressed it became clear that the OOPic did not have some of the functionality that BL2000 required, so the focus of testing was to explore OOPic's value in processing sensors and as a possible adjunct processor. Tests dealt with the results of sensor processing, use of coded OOPic virtual circuit vice hardware, and down load times.

A. BL2000 VERSUS OOPIC

An evaluation of OOPic versus the BL2000 microprocessor shows strengths and weaknesses in both units. A comparison of the specifications are listed in Table 1 [Refs. 1, 9 and 12].

	OOPIC	BL2000
Processing	PIC1F77 @ 20 MHz	Rabbit Microprocessor at 22.1MHz
Memory	2 EEPROM Sockets. 1-8KB installed, upgradaeble	256K Flash memory 128K SRAM
Power	6-15V	9-40V DC or 24V AC, 1.5W Max
Serial Ports	One 2-wire Rx/Tx, which needs RS-232 level converted to communicate with outside computer	RS-232 (3-wire) or one RS-232 (4-wire), one CMOS Channel
Serial Rate	Up to 50,000 baud	Up to 239,400 baud
Digital I/O	Up to 31	Up to 28
Analog I/O	All receive Analog, but does not output Analog voltage	Up to 11
Dual purpose A or D	Up to 7	Up to 7
A to D converters	Up to 7	Up to 9
Digital to Analog	Up to 7	up to 2
Integrated PWMs	2	none
Wireless communications	With serial wireless connection	10Base-T, RJ-45 Ethernet
I2C	Internal clock	Programable
Expandable	Yes	No
Programming	Multi-language: Basic, C, Java	Dynamic C

Table 1. Specifications of OOPic versus BL2000 microprocessor [After: Refs. 1, 9 and 13].

Downloading program files to a microprocessor can be a time consuming endeavor, lasting up to several minutes for larger programs. As a baseline two small files were tested for speed of download to both the OOPic and BL2000. Figure 21 clearly shows the OOPic downloads small files much quicker. The quicker download time can be attributed to the use of Objects in programming as well as the initialization/compiling process required by the individual development environment.

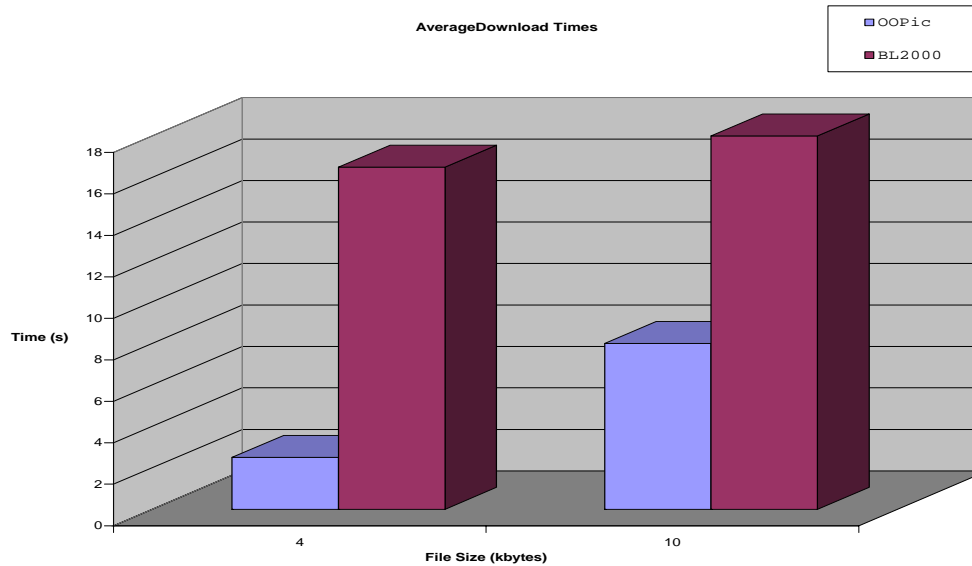

Figure 21. Average file download times for OOPic and BL2000.

In evaluating the use of the OOPic instead of the BL2000 for sensor employed on AGV, several obstacles became apparent. First, the AGV relies on GPS for main navigation, and the BL2000 receives the GPS data via serial input. The data from the GPS is a long data string and is tokenized by the BL2000, interpreted, and then the proper heading is calculated. The OOPic has trouble reading long strings of serial data and properly interpreting them. For example, a standard GPS output is at least 6 characters transferred via serial connection and then tokenized by the micro-processor. The OOPic can only accurately read values up to 64,000, thus omitting at least 1 digit from the GPS. Additionally, the OOPic is not suited to receive and process data that extensive.

The shortcoming the OOPic has in serial data processing is offset by its extensive I2C capabilities. The I2C functionality of the OOPic allows the easy, rapid

processing of numerous sensors in usable data that is easy to process. Exploration of sensors, such as an I2C based GPS module would be ideal for maximizing the potential of the OOPic.

Communications also provide a major difference between the two microprocessors. The BL2000 is equipped with 4 different types of serial ports plus an Ethernet port, which makes communications between the base PC and processor very simple. The OOPic only has serial capability, which has a limited data rate but can be used effectively to control AGV. A major advantage the OOPic has is that the microprocessor can be reprogrammed on the fly via the XBee wireless serial communication suite, whereas the BL2000 must be hard connected via programming cable to the controlling computer. However, extensive future programming will be needed for the OOPic to achieve a PC based control environment to match the current version designed for the BL2000.

B. 802.11G WIRELESS ROUTER VERSUS XBEE WIRELESS MODULE

The methods of wireless communication for the BL2000 and the OOPic are a Netgear wireless router and the XBee module, respectively. The comparison of the Netgear and XBee are listed in Table 2.

	NETGEAR Router	XBee Wireless Module
Protocol	802.11b/g	802.15.4
Frequency	2.4GHz	ISM 2.4GHz
Data Rate	2.4Mbps	0.25Mbps
Tested Range (Indoors)	18m	142m
Tested Ranges (Outdoors)	27m	240-250m
Connection to Micocontroller	RJ-45 Cable	Serial Transmit/Receive
Power Requirements	12V, 1A	2.8-3.3V up to 215mA for
Weight	1.08lbs (0.49kg)	1.0oz

Table 2. Specification of Netgear Wireless Router versus XBee Wireless Module [After: Ref. 5].

Maintaining communications between the base computer and with AGV's micro-controller is essential to successful operations. Several evaluations between the Netgear and XBee wireless routers were conducted with their respective micro-controller.

The operating ranges of the wireless routers were tested indoors and outdoors. Each router was connected to their respective micro-controller and was turned on, with a program downloaded designed to report data back to the base computer. The laptop was then moved a distance away, constantly testing the connection by observing the incoming data. Indoors, the routers were placed in a room with a closed door and the base computer was walked down the hall. The Netgear router consistently lost connection at 55-60 feet, while the XBee maintained connection until 130-145 feet. Outdoors the Netgear router saw ranges up to 100 feet, and the XBee lost connection between 750-785 feet. The large variation in the ranges is for two reasons. First, the 802.15.4 protocol uses more power per megahertz than the 802.11 protocol. Second, the XBee uses a modulation process called offset quadrature phase-shift keying (OQPSK) that results in higher receiver sensitivity.

There is a significant difference in maximum data rates, with the Netgear operating at 2.4Mbps and the XBee operating at 0.25Mbps. However, they each provide transmission rates that are in line with the capabilities of their respective micro-controllers.

Additionally, there is a significant differential in power usage. The Netgear consumes approximately 1 Ampere (A) constantly, while the XBee takes 215 mA when transmitting, and 25 mA when receiving or idle.

Based on evaluation, each router works very well for their micro-controller configuration.

C. PULSE WIDTH MODULATION (PWM)

The OOPic has a robust capability of emulating hard circuits in what are called virtual circuits, including Pulse Width Modulation (PWM). The AGV used the PWM circuit shown in Figure 22 to drive the motor controllers. The speed and direction for the motor controller was determined by the duty cycle of the PWM.

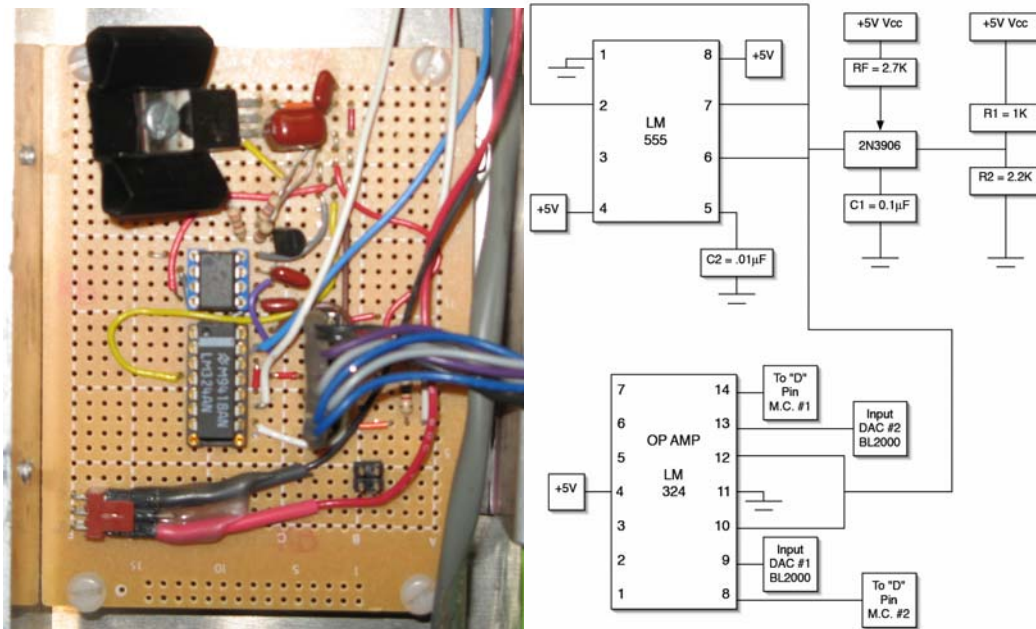

Figure 22. (A) The actual PWM circuit on AGV. (B) The PWM circuit diagram. [From: Ref. 6].

The OOPic was then programmed to replicate the PWM designed to drive the motor controllers on AGV. Using oPWM

object the program expects 3 values, called properties, to form the PWM. The pre-scale property set the clock value, taking the 5MHz base frequency and dividing it by 1, 4, or 16. The period sets the active time period for the cycle; it is an integer 0-255. The value property sets the duty cycle and is an integer from 0 up to the number given for the period. So the duty cycle is the value divided by the period [Ref. 1]. A simple program listing for a 50% duty cycle is listed in Figure 23.

```

Dim pwm As New oPWM
Sub main()

pwm.IOLine=18      'puts PWM out of line 18
pwm.Operate=1      'starts PWM

pwm.PreScale=2     'sets PWM scale to 312.5kHz
pwm.Period=230     'sets period (0-255)
pwm.Value=115      'sets duty cycle(DC). Value/Period = DC

End Sub

```

Figure 23. OOPic program listing for 50% duty cycle.

For the motor controller on AGV a duty cycle of 0% or constant 5V represents full speed reverse and a duty cycle of 100% or constant 0V represents full speed forward. There is a linear relationship for corresponding duty cycles and speeds [Ref. 2]. The AGV controlled by the BL2000 and PWM circuit requires a voltage from the BL2000 into the PWM, which changes the duty cycle and results in the AGV motion [Ref. 6]. In the OOPic produced PWM, the program will process the sensor inputs into a number that is defined as Value property of the PWM. The ratio of the

constantly updating Value property to the Pre-scale property will change the duty cycle of the PWM, thus changing speeds for the motors.

The results of various duty cycles for the OOPic and the AGV circuit were placed on an oscilloscope and compared. The 50% duty cycle is shown in Figure 24. The 75% duty cycle is shown in Figure 25. The figures show that OOPic produces the same signal as the circuit without the need for a pull up voltage required by the circuitry.

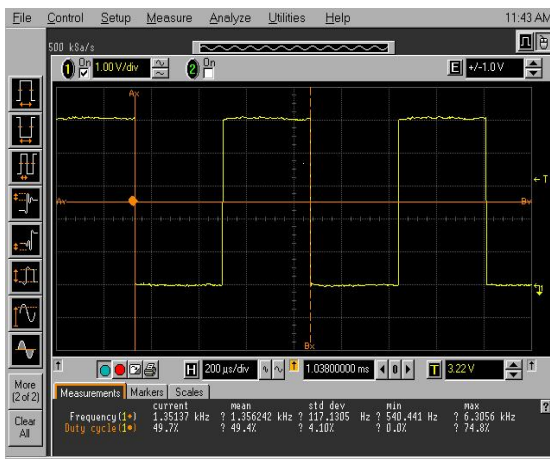

(A)

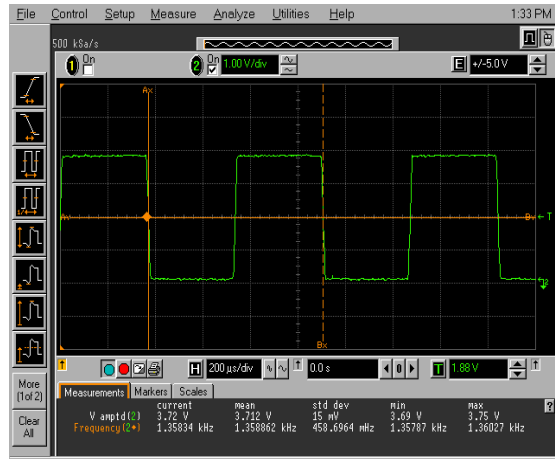

(B)

Figure 24. PWM waveform output for 50% duty cycle. (A) OOPic. (B) AGV circuit [From: Ref. 6].



(A)

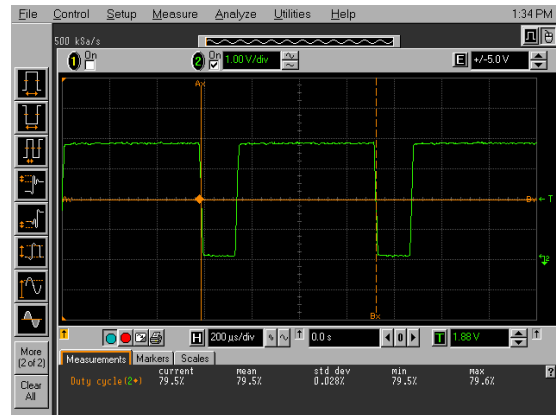

(B)

Figure 25. PWM waveform output for 75% duty cycle. (A) OOPic. (B) AGV circuit [From: Ref. 6].

D. INFRARED RANGE FINDER

The evaluation of sensor data as processed by the OOPic and BL2000 was also very important, with the focus given to the collision avoidance sensors, especially the SRF08 Ultrasonic Range Finder and the GP2D12 Infrared Range Finder. The IR Ranger was tested with the BL2000 and the OOPic, measuring the output voltage versus distance to an object and compared to published data from Sharp as shown in Figure 26. Once the voltage reaches a maximum it begins to decay as a function of the distance. Both the BL2000 and the OOPic are very close in results to the published data with the OOPic following slightly closer to the Sharp data especially through the voltage decay. It is also clear that under approximately 10 cm the voltages can vary wildly and cause unreliable data.

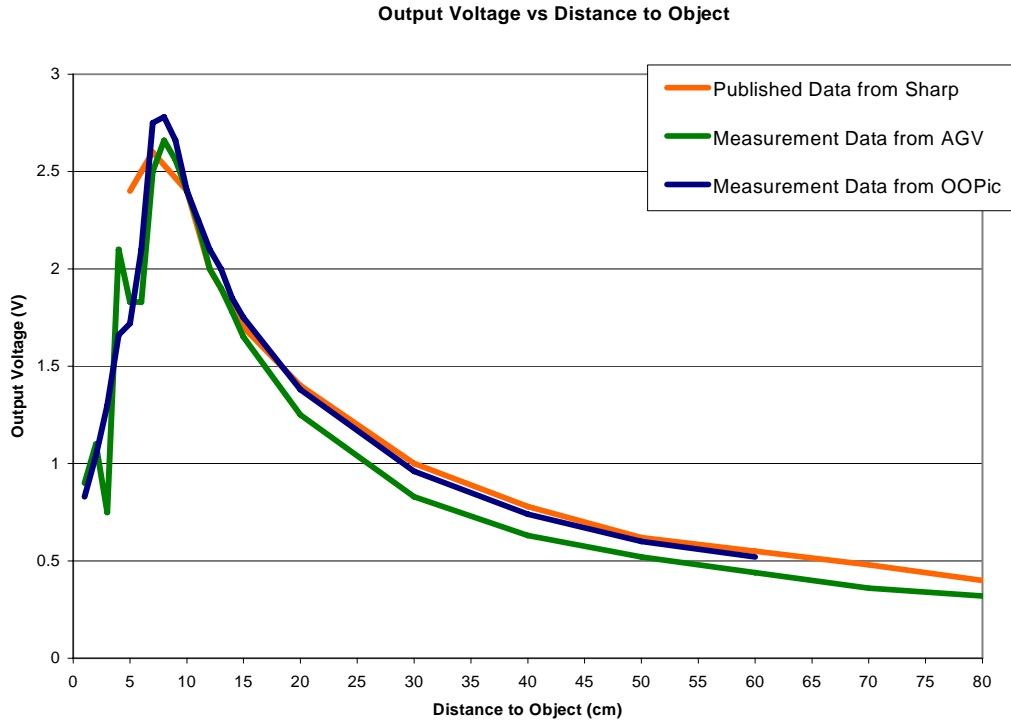

Figure 26. Output voltage versus distance to objects for the IR ranger [After: Refs. 6 and 11].

The GP2D12 Infrared Range Finder is the main collision avoidance sensor for AGV. There are significant differences in the process of the GP2D12 by the BL2000 and the OOPic. Currently, the BL2000 receives an analog signal from the GP2D12, and if the voltage from one of the forward-looking sensors exceeds a set threshold that indicates an obstacle, it then references the side rangers. The BL2000 then decides which way to turn to avoid collision depending on which side allows for greater clearance [Ref. 6].

The OOPic has a more elegant internal method for calculating the ranges. The OOPic has an internal object that receives the analog voltage and immediately processes it to a digital number from 1 to 128 based upon an internal calculation, shown graphically in Figure 27. Additionally, in Figure 27 it shows the digital conversion maximized at 128 for the analog voltages under 0.5 V. The clipping at 128 can be attributed to oIRRanger Object within the OOPic. The Object was written to effectively detect targets at distances up to 24 inches or 81 cm and 0.5 V falls right on the maximum operating distance, so any small voltage return will indicate that target is at least at maximum effective range or 24 inches. In testing it was seen that the OOPic actually produced digital readings of 20 to 128. A problem arose when the IR Ranger did not detect an object; it returned a digital value of 20, which also corresponds to the value at maximum voltage.

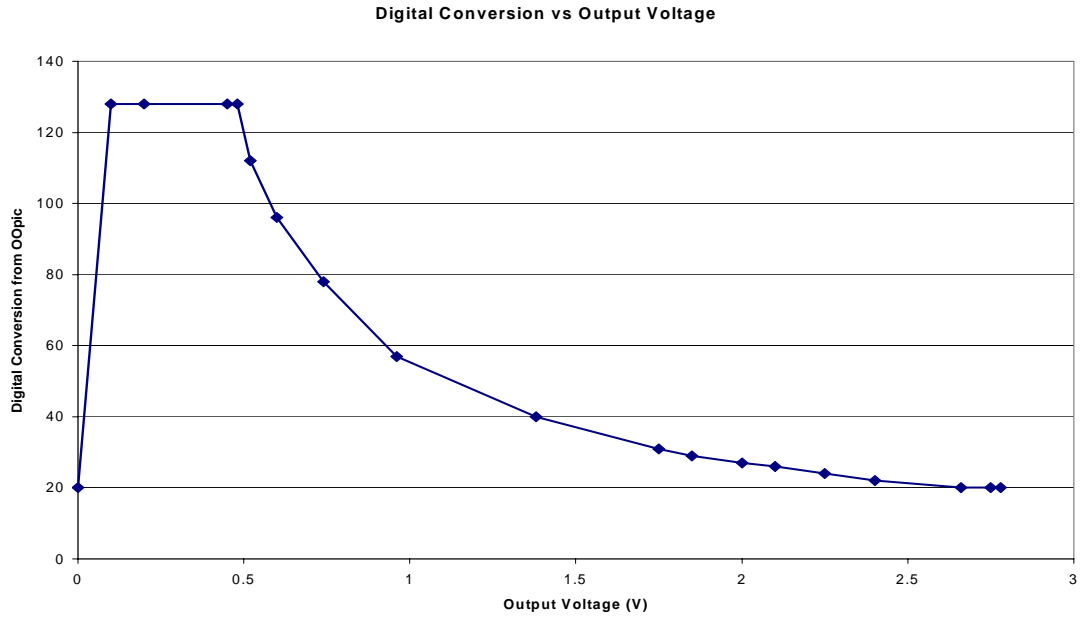

Figure 27. OOPic Digital Conversion versus Output Voltage.

The OOPic takes what was a highly non-linear voltage to distance relationship and makes it linear and easily convertible to any distance unit knowing that the maximum range is 24 inches or 61cm. Figure 28 shows digital value versus centimeters measured to the object and compares it to the calculated distance to the object. It shows that as expected, any distance under approximately 10cm will not be seen, confirming the data in Figure 26 where each voltage can have two possible distances. The calculation in the OOPic will not provide a distance under 10cm because that is where the digital value reaches a minimum and has increasing values on either side. Equation 3 shows the equation for the line in Figure 28. Equation 3 adds a factor of 1.1 to the original formula in Equation 2 because the distances were uniformly short.

$$\text{Distance(cm)} = 1.1 * (\text{DigitalValue} * 61/128)$$

Equation 3. Updated Range equation for the IR Ranger.

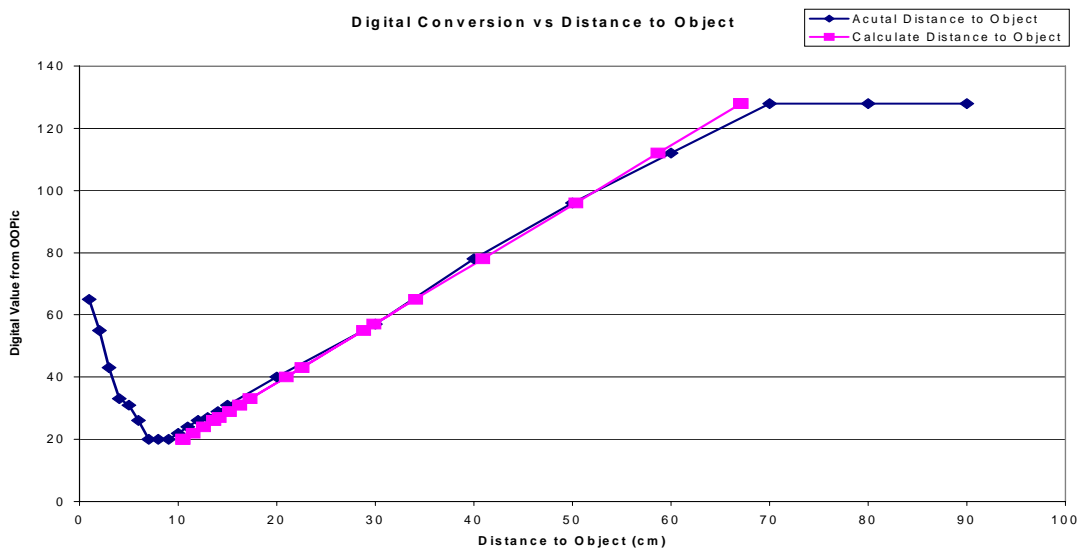

Figure 28. OOPic Digital Conversion versus Distance to Object for IR Ranger.

When the IR Rangers and OOPic are used for object avoidance, the OOPic will have to be programmed to account for the digital readings under 10cm, as the digital reading under 10 cm will calculate increasing ranges although the object is actually getting closer. Additionally, the case where the IR Ranger does not have contact with an object must be addressed.

E. SRF08 ULTRASONIC RANGE FINDER

The SRF08 Ultrasonic Range Finder is the other sensor designed to determine range to an object. The SRF08 is connected to the micro-controller via the I2C bus as shown in Figure 6. The SRF08 was connected to the BL2000 and the OOPic, and each was then tested to determine range returns off of different materials. The materials were walls, plexiglass, and metal. The results showed average returns

within half an inch for the OOPic and BL2000. The results of the testing are shown in Figure 29. There is one significant draw back with the SRF08, and that is when there is ambient noise or other sensors operating at frequencies close the 40kHz produced by the SRF08. This effect was seen when both the BL2000 and the OOPic were operating their SRF08s at the same time, while in close proximity. The data integrity seen from each micro-processor was significantly diminished with returns of 15-17 inches for an object at 72 inches. If more than one SRF08 will be utilized on a platform, proper phasing will be essential. Additionally, this could eventually be problematic if more than one platform is used in close proximity.

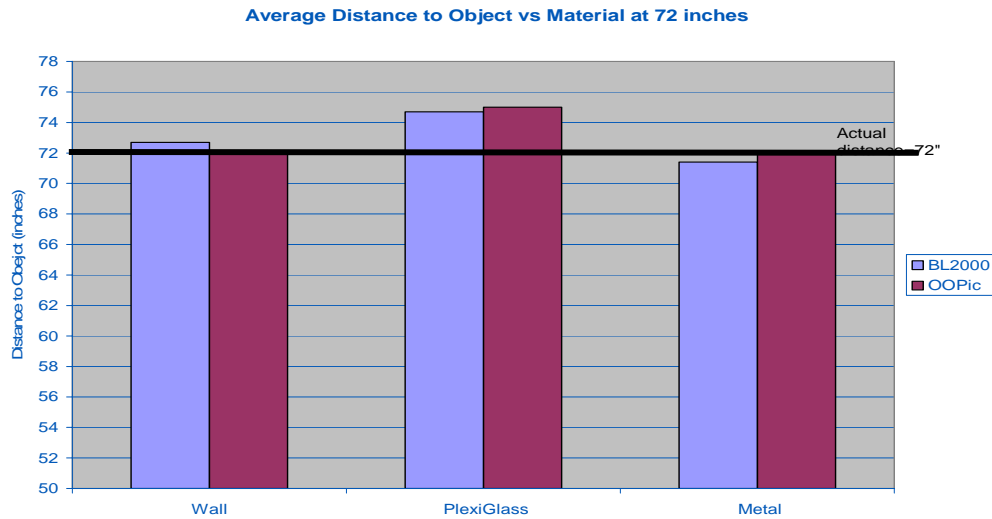

Figure 29. SRF08 distance to object for BL2000 and OOPic for various materials.

THIS PAGE INTENTIONALLY LEFT BLANK

IV. CONCLUSIONS AND FUTURE WORK

A. CONCLUSIONS

The OOPic proved to be a very useful micro-controller for the handling of AGV's sensors. It provided intuitive processing for the sensors, taking advantage of its significant digital capabilities and I2C bus. However, the internal processing of the OOPic is not robust enough to execute all of the autonomous functions of needed by AGV. An ideal solution would be to operate the BL2000 and the OOPic in tandem, taking advantage of the OOPic's sensor processing ability and I2C bus to manage the sensors and be utilized for collision avoidance. The BL2000 would be used to process the autonomous GPS based navigation.

B. FUTURE WORK

A significant amount of future work includes striking the proper balance of sensors integration, communication and the utilization of both the OOPic and BL2000 microprocessor.

Each microprocessor has its strengths, and thoughtful integration between the two could lead to far more robust capabilities for AGV. Specifically, the OOPic could be easily handle the sensor processing and collision avoidance, while the BL2000 can handle the communications and basic waypoint navigation. The use of OOPic can free valuable processing along with shortening coding loops, which will shorten the time scale on which the BL2000 does calculations. Additionally, the OOPic should be used to control the PWM; getting away from the current circuit

work, the software solution in the OOPic vice the hardware PWM would provide a flexible, programmable signal for motor control.

Researching additional sensors that could be used with the OOPic, to take advantage of its full functionality would be worthwhile. I2C devices such as a DS-GPM Global Positioning System Module (Figure 30) would be ideal, taking advantage of the robust I2C bus and possibly combining some vital sensor such as GPS, heading, speed log. Additionally, a viable camera option needs to be explored, and possible solution may be the CMUCAM (Figure 30), which would provide low power, real-time video/snapshots at 17 frames per second [Ref 14]. It would be ideal because it is designed for use with low power processor such as PICs.



Figure 30. DS-GPM Global Positioning System Module
[From: Ref. 13].



Figure 31. CMUCAM, low power alternative to web cam
[From: Ref. 14].

Considering potential intended uses for the AGV a future project may consider utilizing the Army and Marine Corp Blue Force Tracker, and explore potential integration into either the OOPic or BL2000 coding.

THIS PAGE INTENTIONALLY LEFT BLANK

LIST OF REFERENCES

- [1] CLARK, .C. *Programming and Customizing the OOPic Microcontroller*. McGraw-Hill, 2003.
- [2] DUNBAR, T. Demonstration of waypoint navigation for a semi-autonomous prototype surf-zone robot. Master's Thesis, Naval Postgraduate School, June 2006.
- [3] EMBEDDED.COM. Introduction to I2C.
<http://www.embedded.com/story/OEG20010718S0073>,
November 2006.
- [4] FRADEN, J. *Handbook of Modern Sensors, 3rd Ed.*,
Springer-Verlag New York, Inc. 2004, pp. 286-288.
- [5] MAX STREAM. XBee/XBee-Pro OEM RF Module.
http://maxstream.net/products/xbee/manual_xb_oem-rf-modules_021.15.4.pdf, November 2006.
- [6] MILLER, B. Improvised Explosive Devise Placement Detection from a Semi-Autonomous Ground Vehicle. Master's Thesis, Naval Postgraduate School, December 2006.
- [7] PHEATT, C. *Integrating OO Concepts into a CS0 Course*. Emporia State University.
- [8] PHILIPS. The I2C-bus and how to use it.
<http://www.mcc-us.com/i2cHowToUseIt1995.pdf>, November 2006.
- [9] SAVAGE INNOVATIONS. <http://www.oopic.com>, November 2006.
- [10] SUPERDROID ROBOTS. SRF08.
http://www.superdroidrobots.com/product_info/SRF08.htm,
August 2006.
- [11] SUPERDROID ROBOTS. GP2D12.
http://www.superdroidrobots.com/product_info/SharpGP2D12-15.pdf, August 2006.
- [12] Z-WORLD. BL2000.
<http://www.zworld.com/products/bl2000/>, August 2006.

- [13] ACRONAME PRODUCTS. DS-GPM Global Positioning System Module. <http://www.acroname.com/robotics/parts/R217-TR-GPM.html>, August 2006.
- [14] CMUCAM. CMUCAM Vision Sensor. <http://www.cs.cmu.edu/~cmucam/home.html>, August 2006.

INITIAL DISTRIBUTION LIST

1. Defense Technical Information Center
Ft. Belvoir, Virginia
2. Dudley Knox Library
Naval Postgraduate School
Monterey, California
3. Physics Department
Naval Postgraduate School
Monterey, California
4. Richard Harkins
Department of Applied Physics
Naval Postgraduate School
Monterey, California
5. Nancy Haegel
Department of Applied Physics
Naval Postgraduate School
Monterey, California